

inside

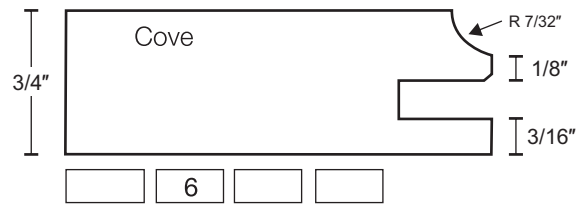

*Note: On Bevel V Groove runs through the joint

inside

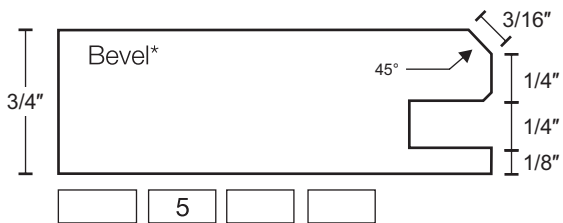
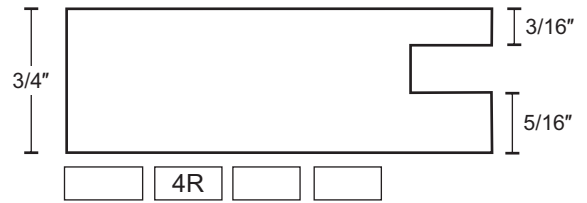
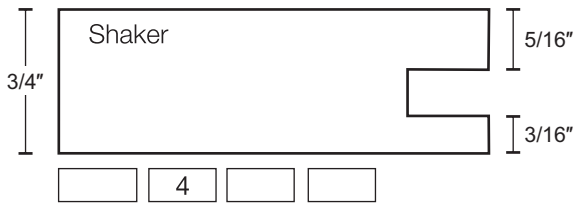
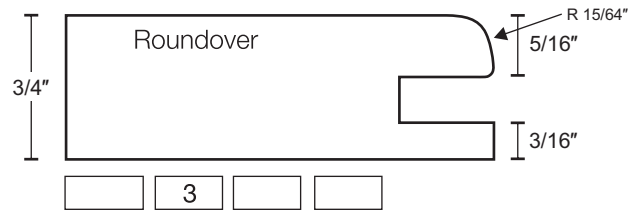
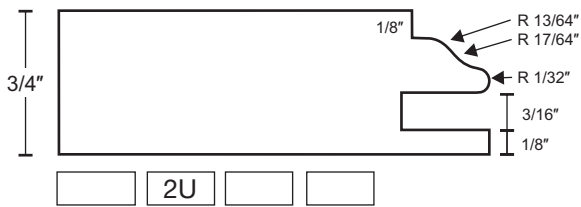
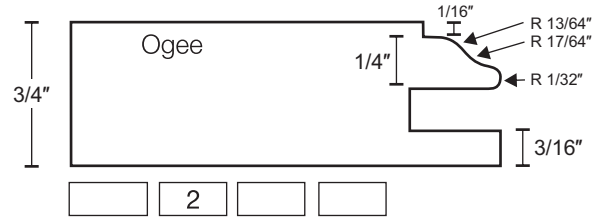
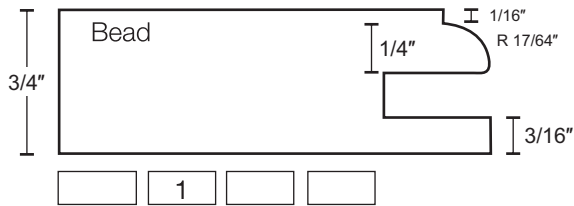
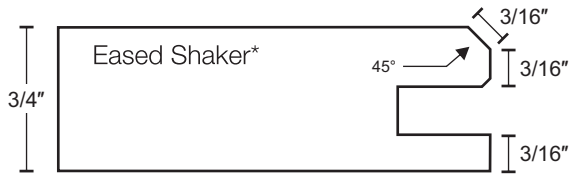

*Note: On Eased Shaker V Groove does not run through the joint

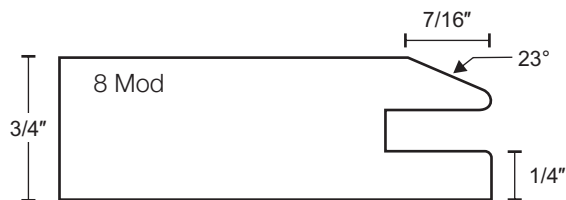
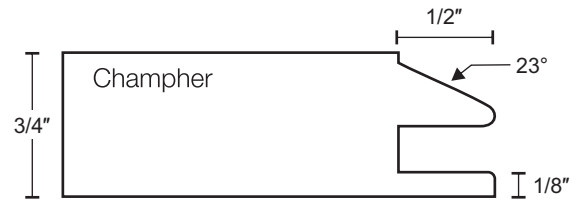

*Note: 1/4" reveal on face.

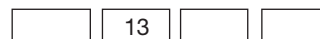
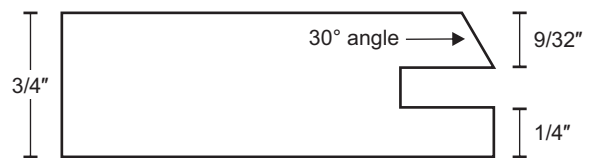
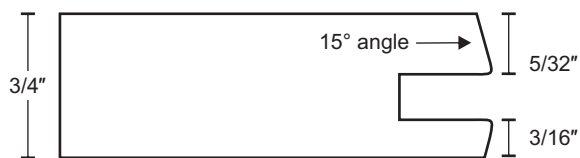
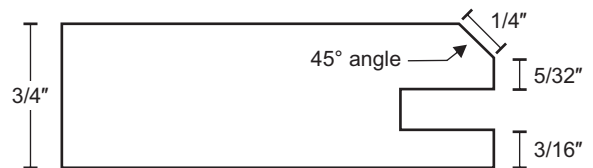
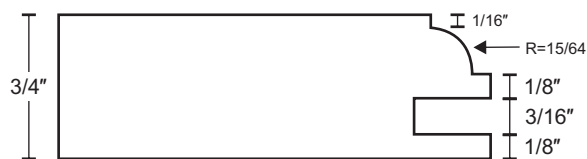

inside

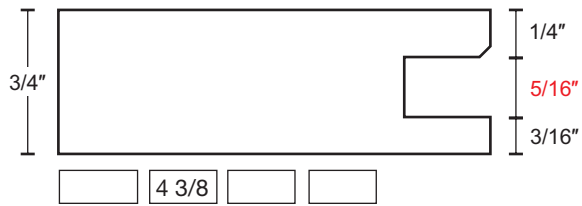
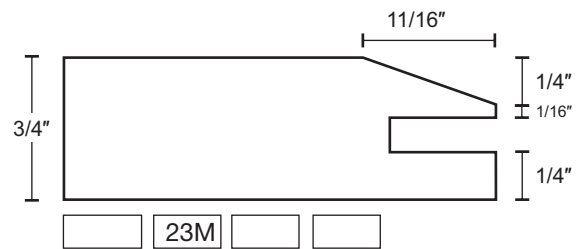
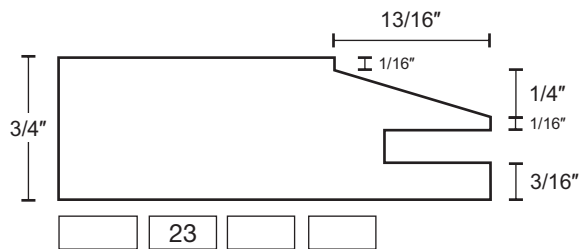
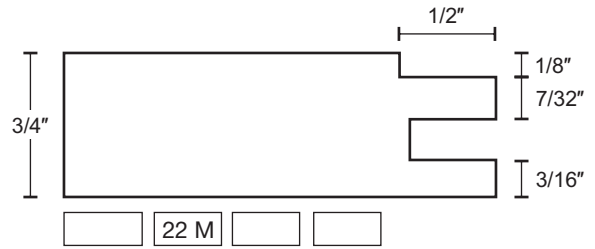
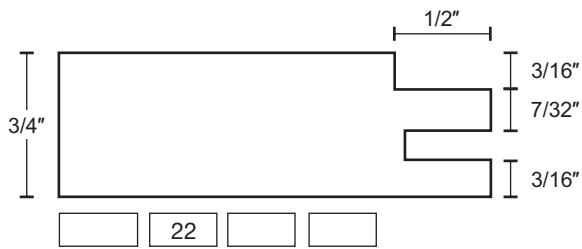

arches

Square

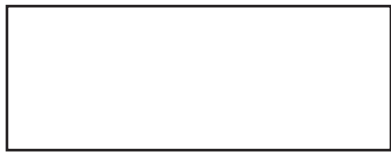

100

Standard

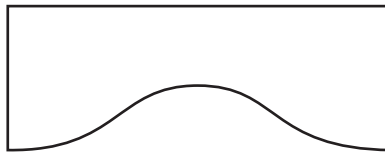

200

Shallow

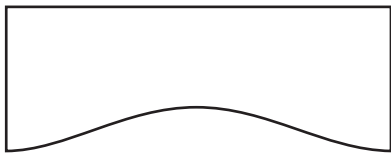

300

Gentle Arch

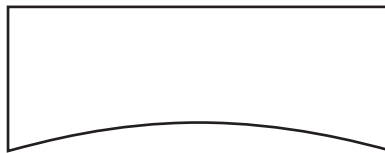

400

"V" Top

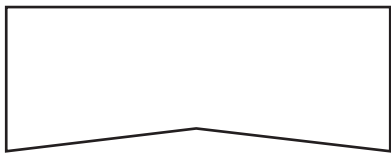

500

Hudson

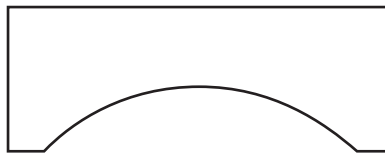

600

French

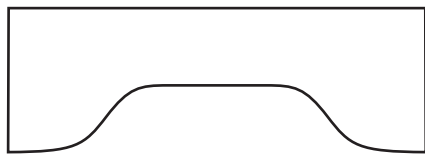

700

panel raise

Acadia

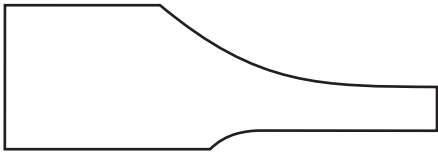

Beardsley

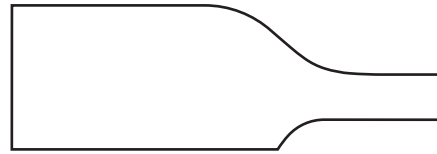

Celtic

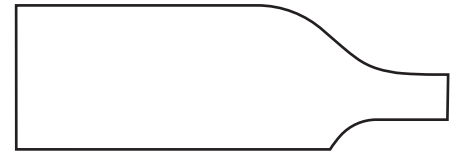

Empire

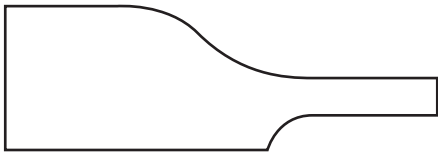

Huguenot

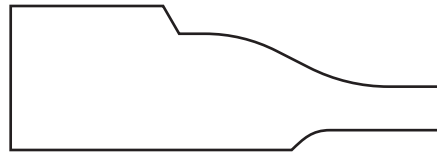

Harvard

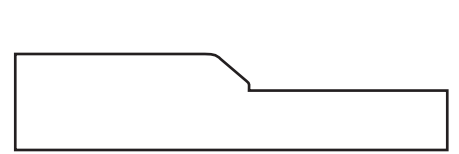

Jubilee

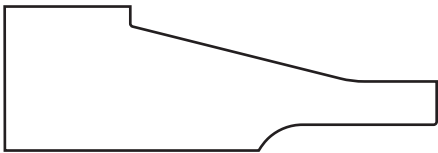

JMod

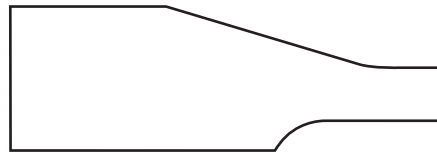

Kipling

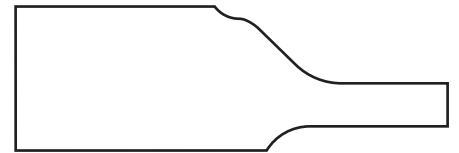

Liberty

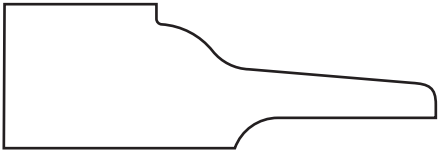

NMod



Normandy

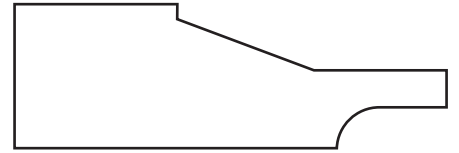

panel raise

Plywood

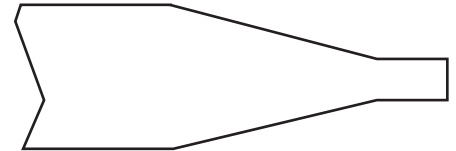
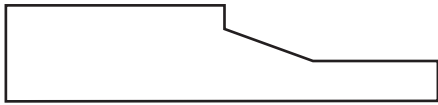

Solid



Solid Bead



Solid V Groove

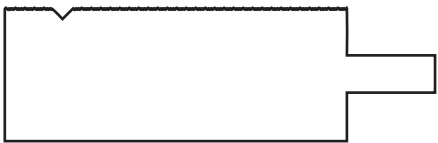

*rough sawn face with micro v-groove

Winston



outside

1/4 Cove

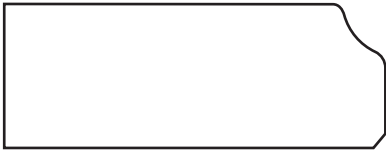

Ogee

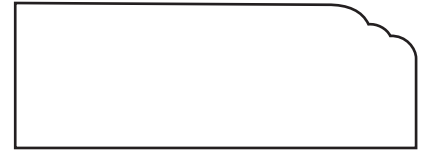
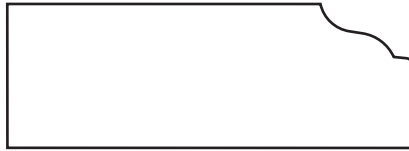

1/4 Roundover



Bead



Eased Bead

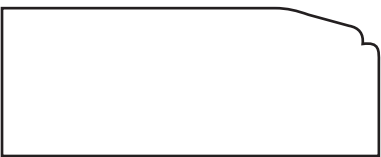

1/8 Cove

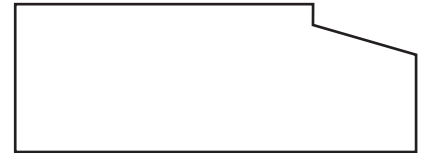

Bevel



Chamfer

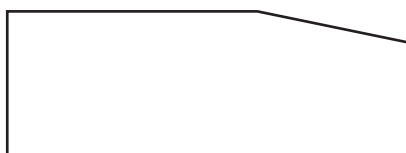

outside



Square



Eased Square

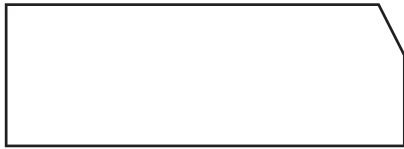
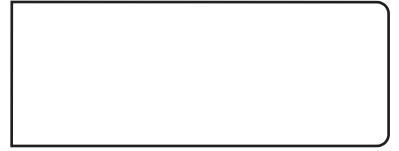

3/8 Roundover



Bullnose



Cove

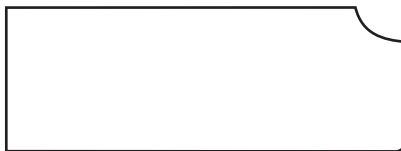

mitre

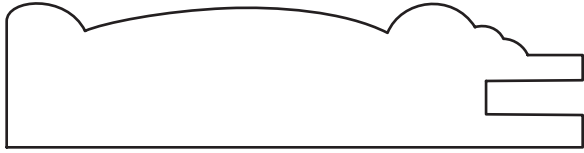

2100

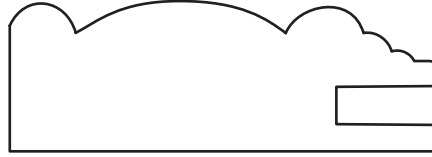

2150

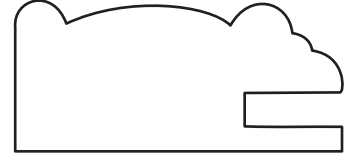

2175



2200



2203

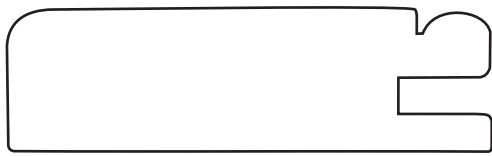

2250

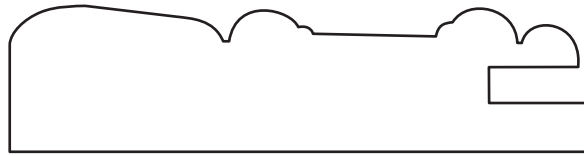

2300

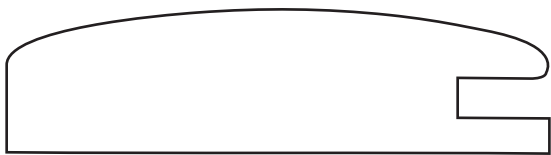

2400

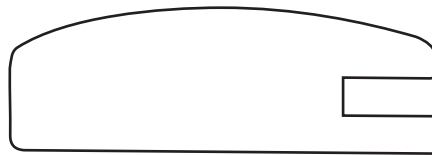

2450



2500



2575

mitre

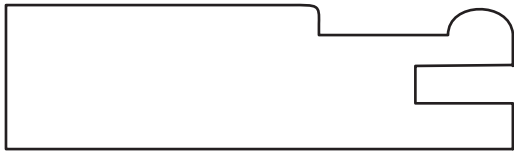

2600

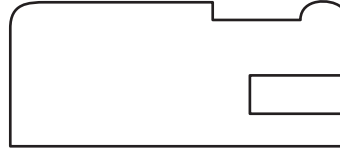

2675

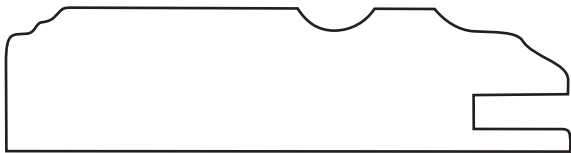

2700



2800

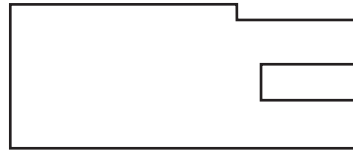

2875



2900

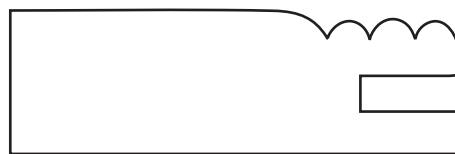

2950



3100

mitre



3200



3350



3400

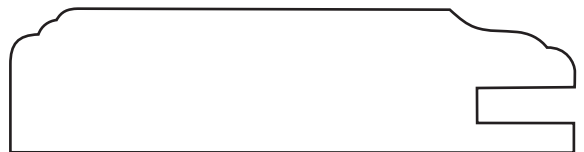

3500



3600



3700



3750

mitre

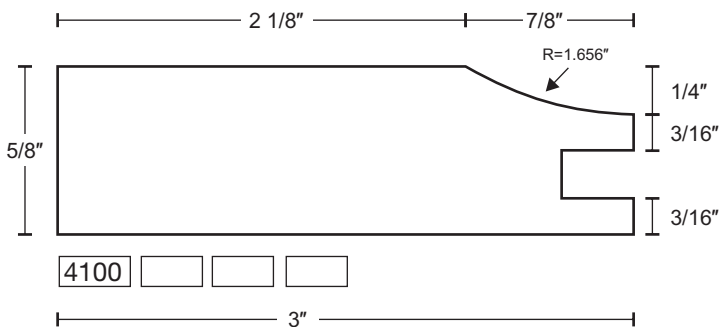
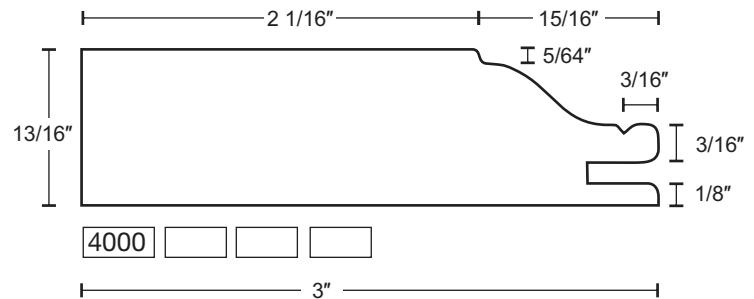
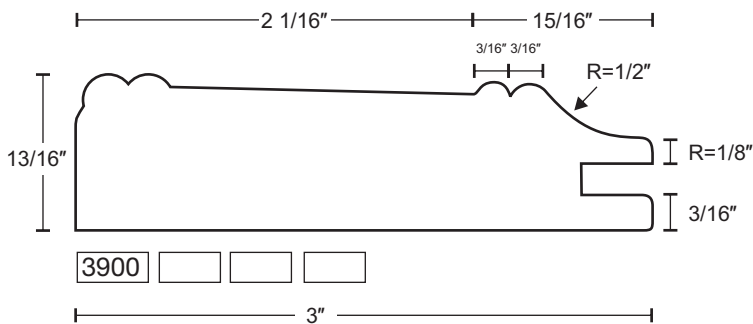
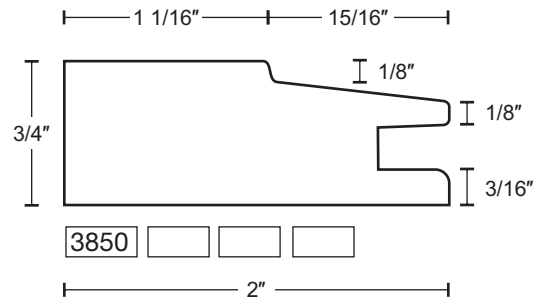
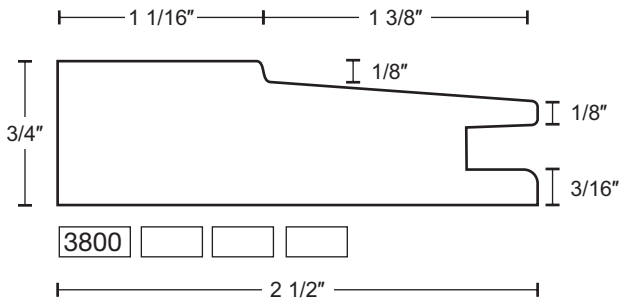

1 piece MDF series

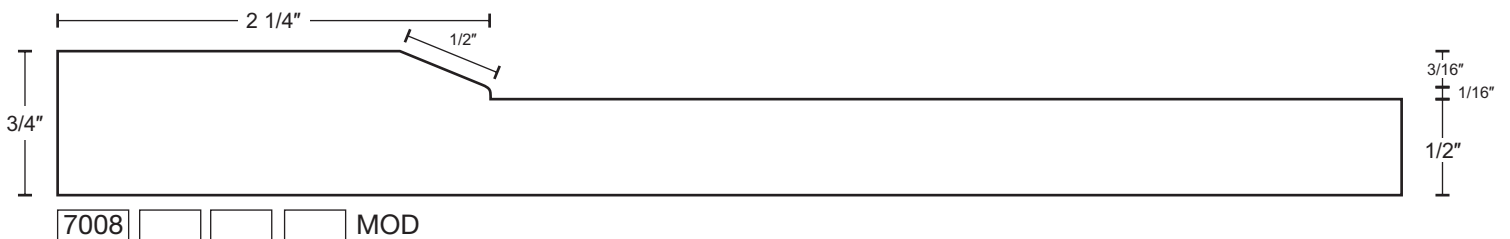
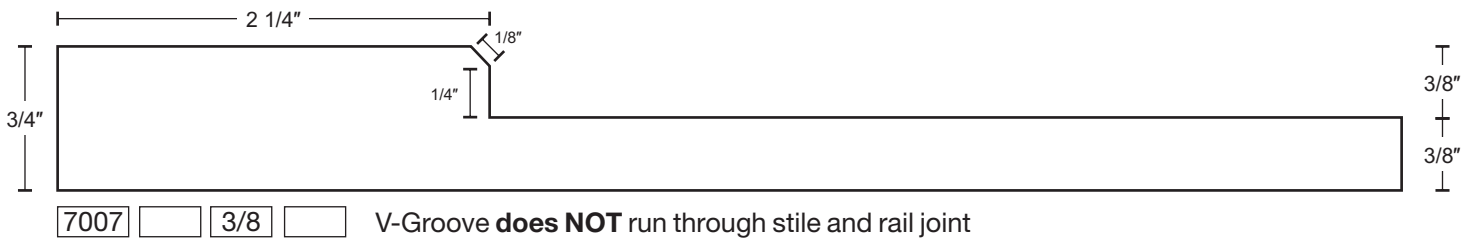
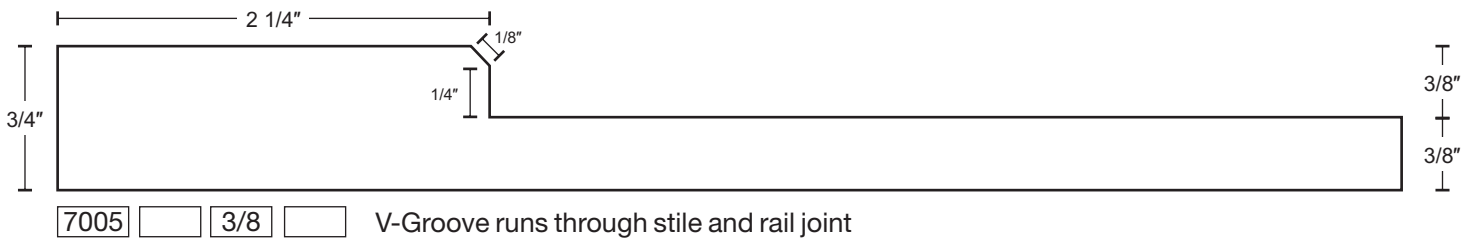
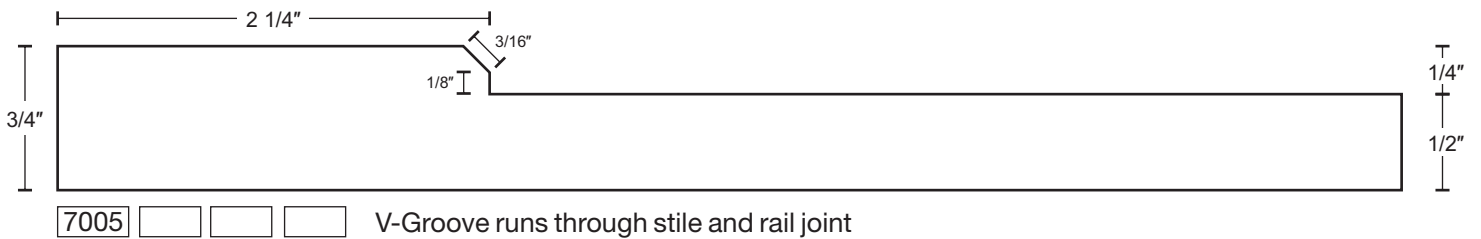
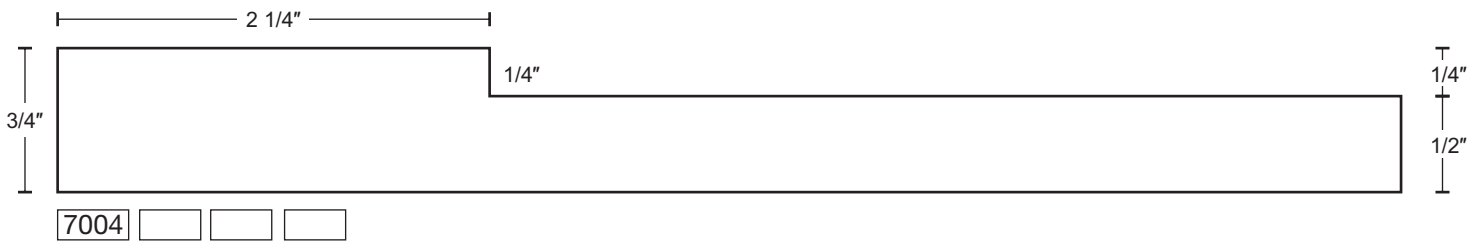

1 piece MDF series

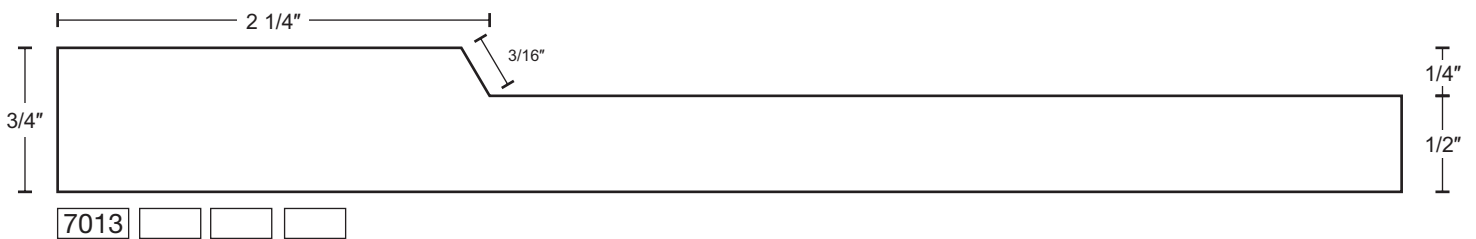
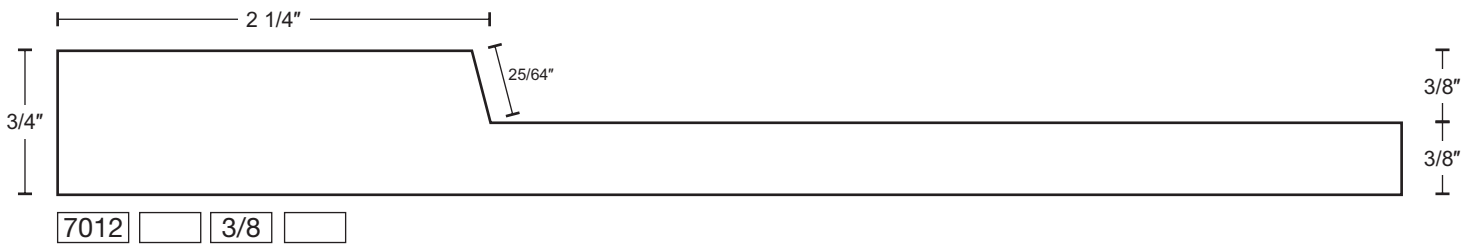
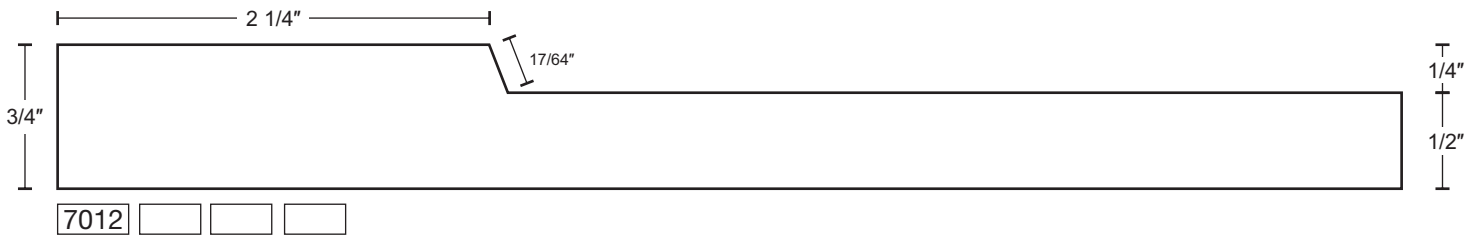
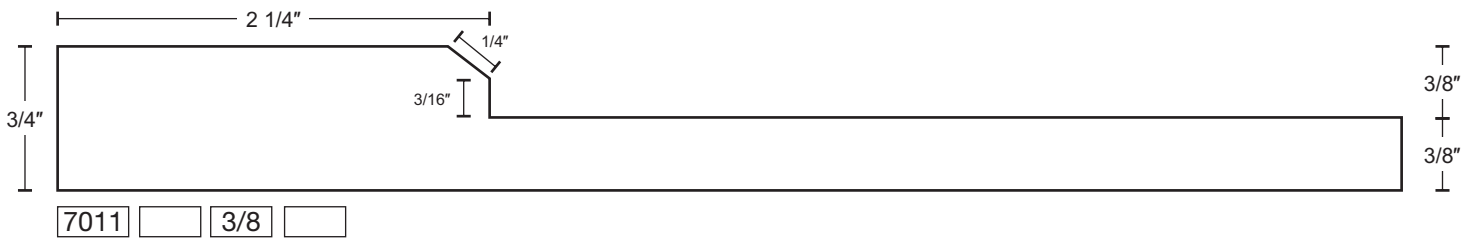
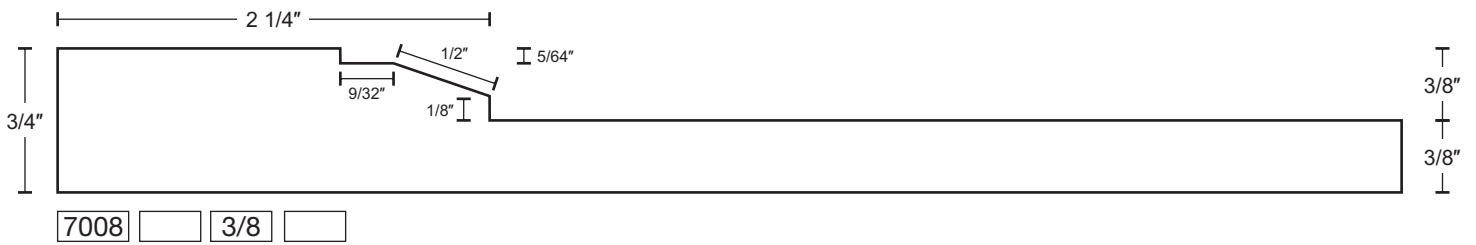

1 piece MDF series

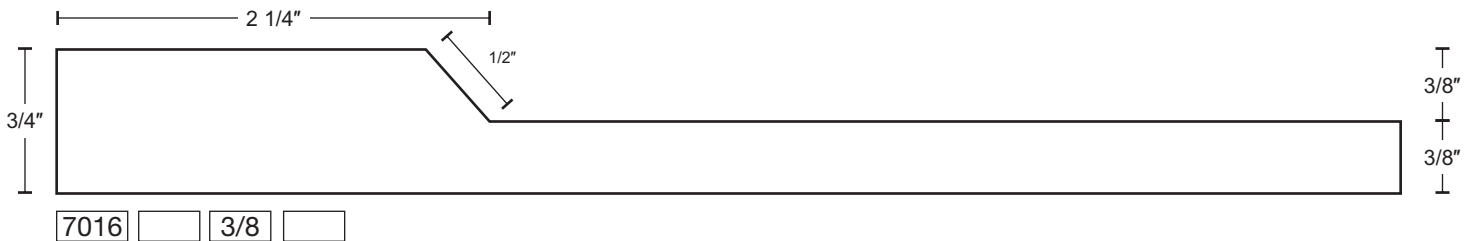
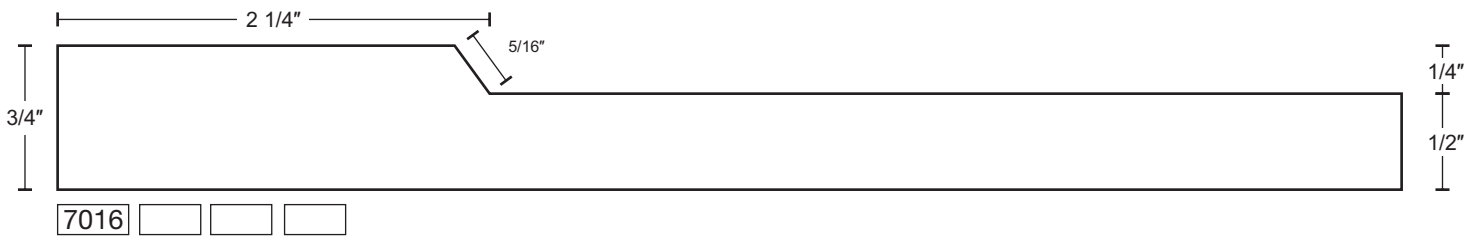
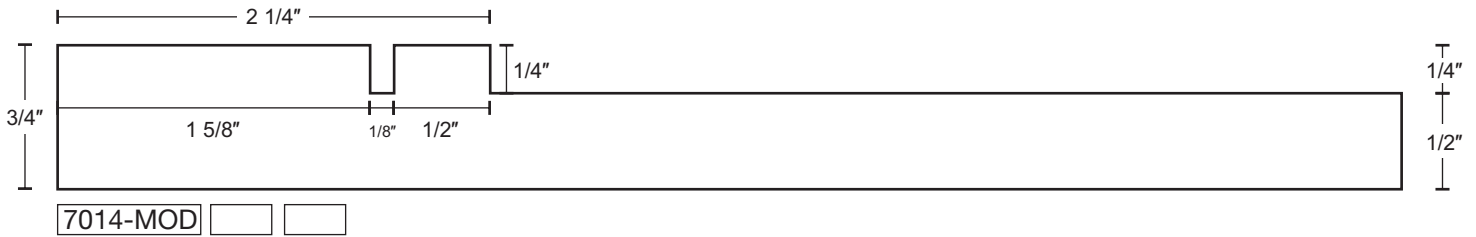
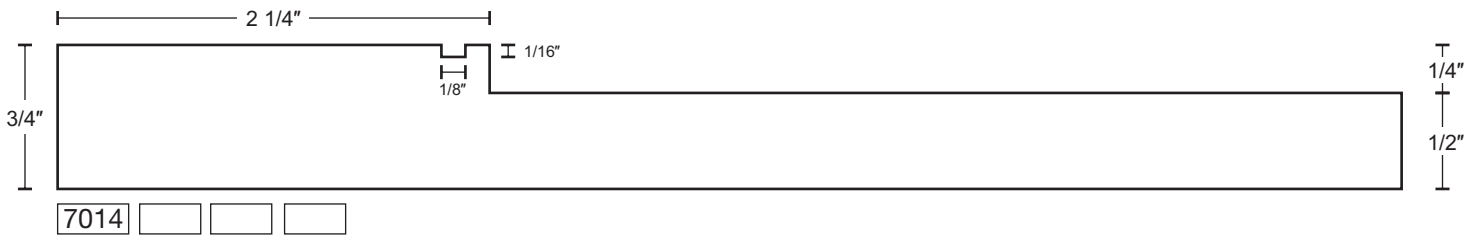
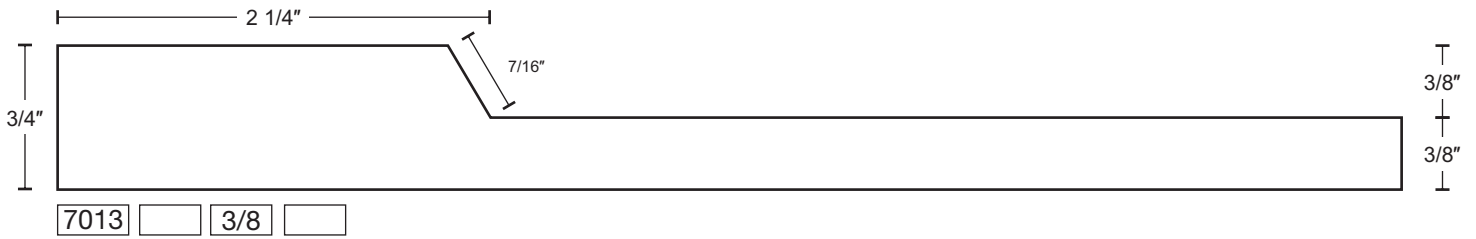

1 piece MDF series

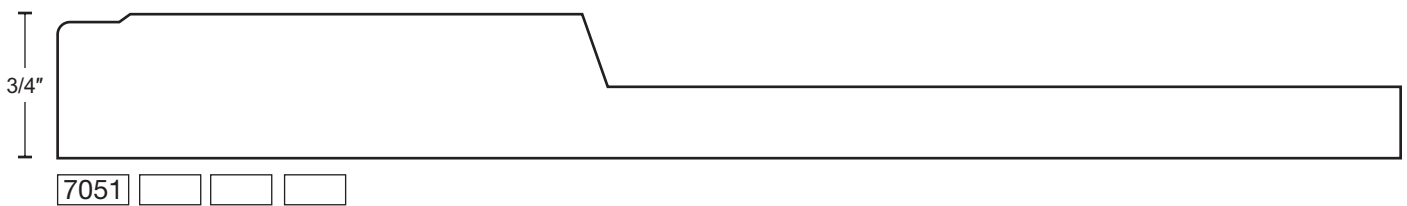
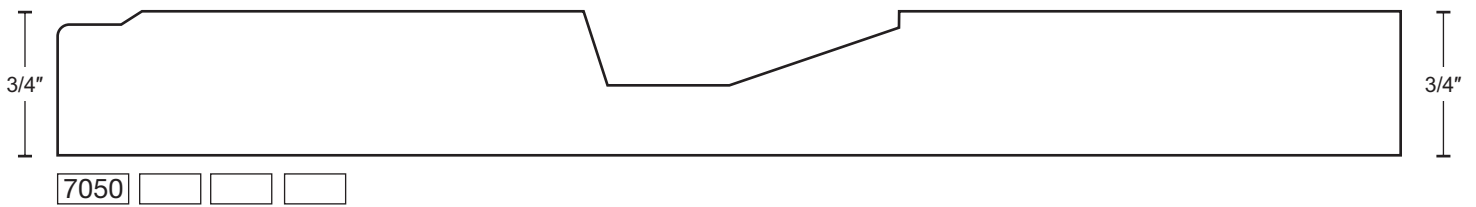
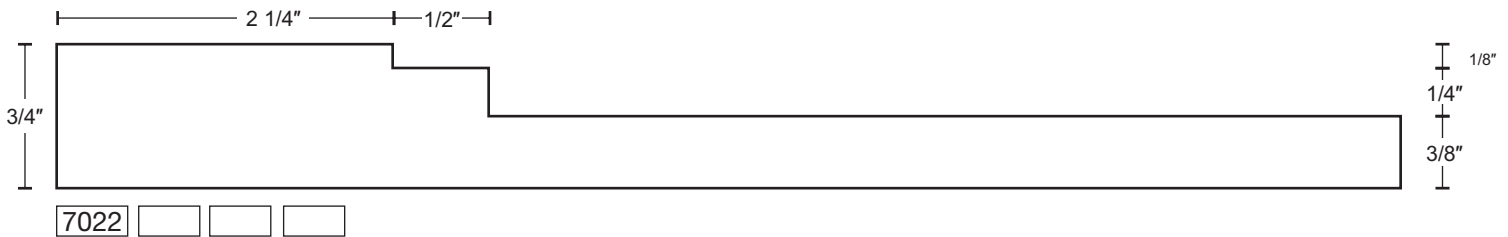
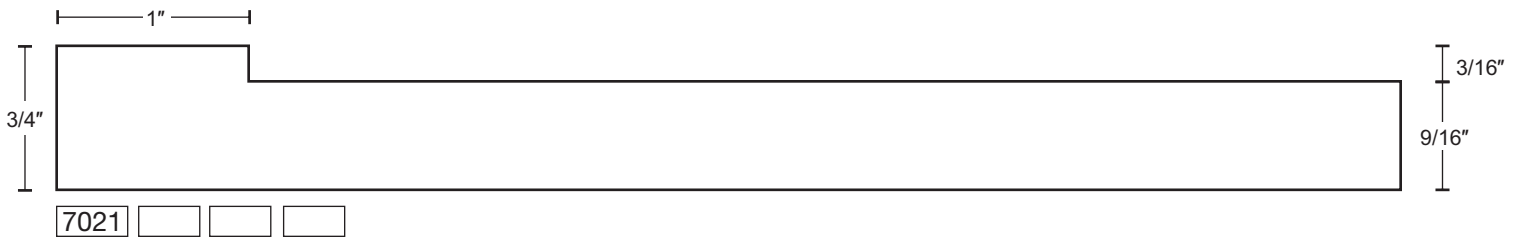
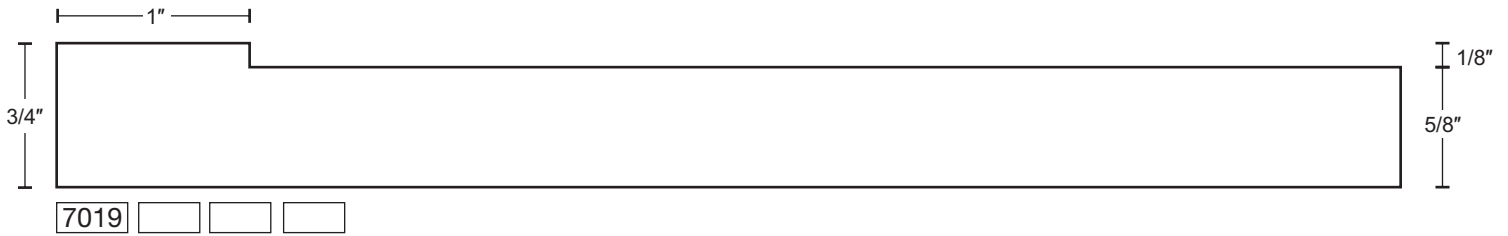

1 piece MDF series

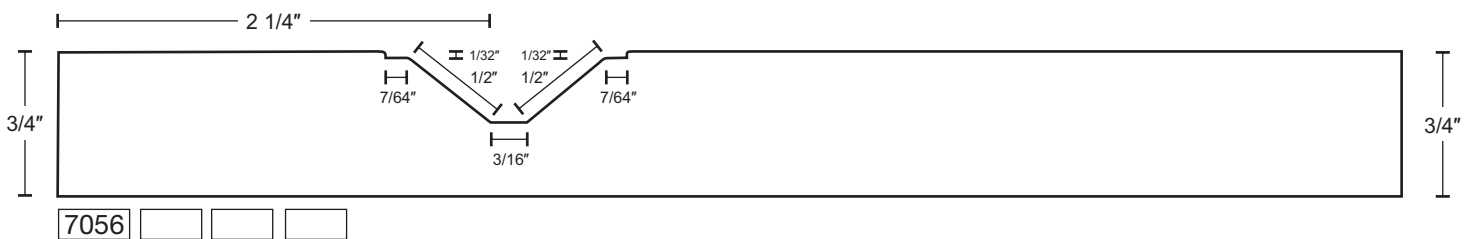
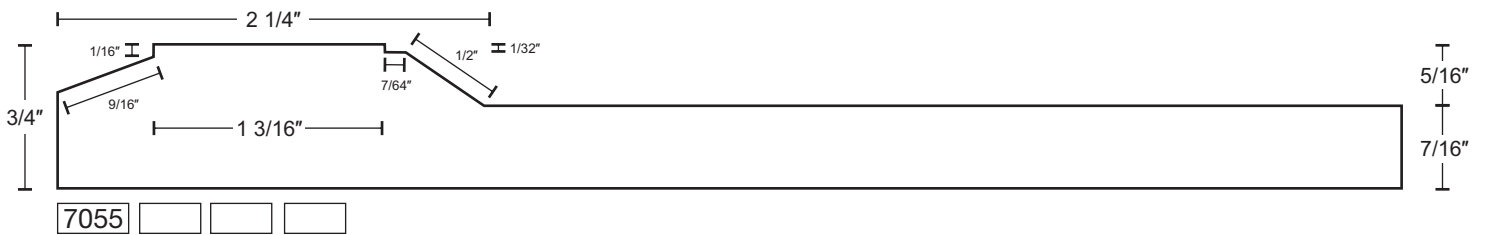
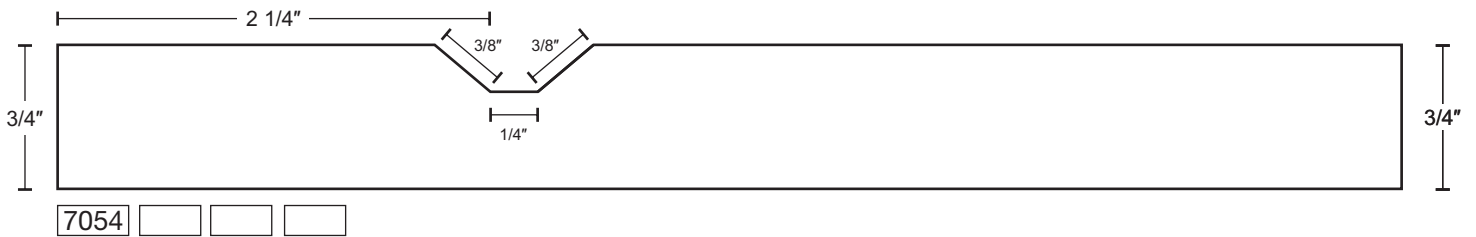
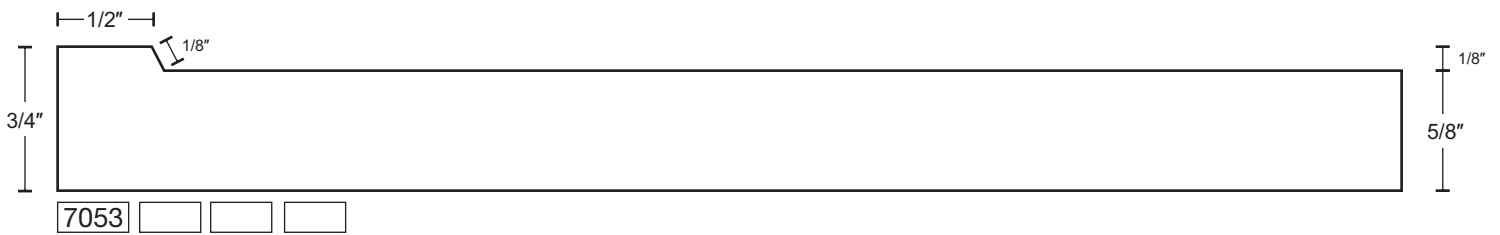
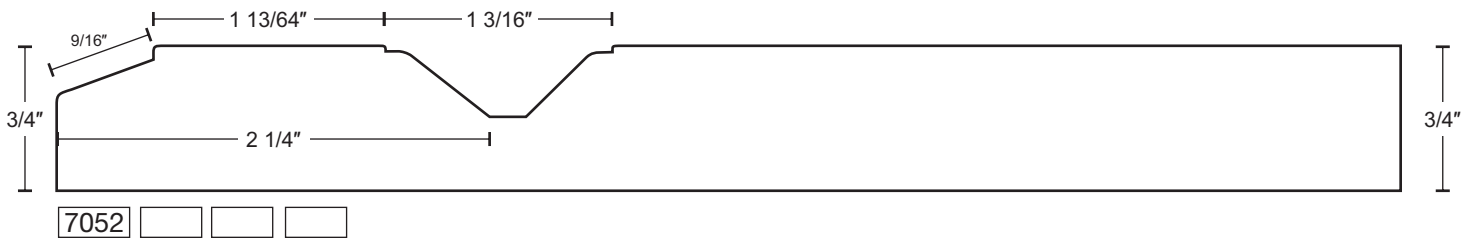

1 piece MDF series

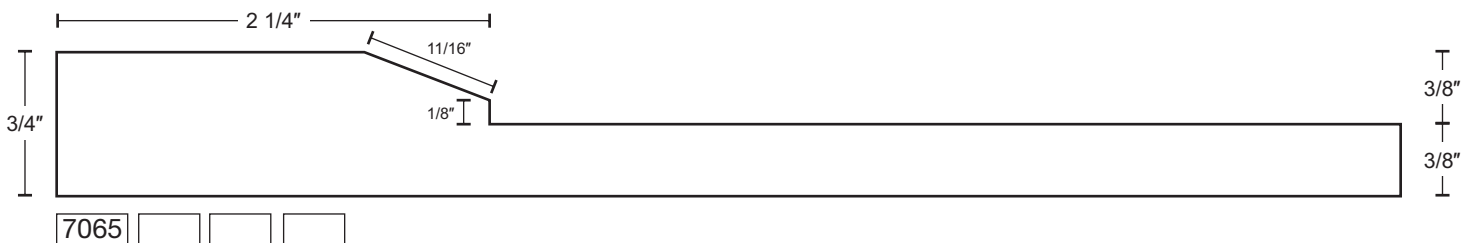
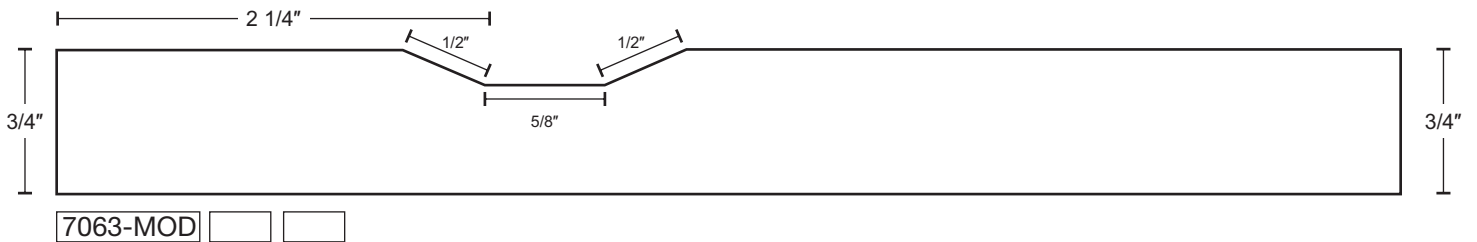
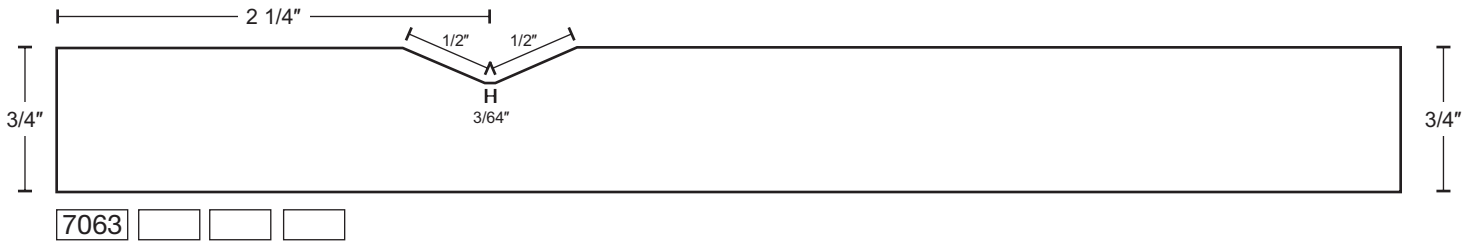
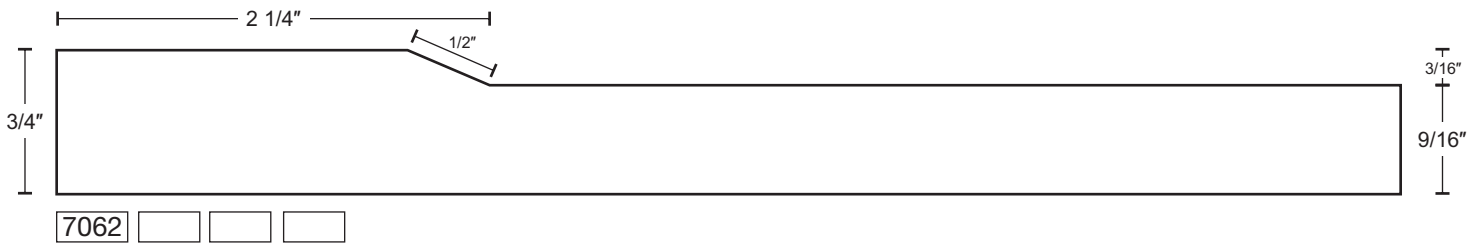
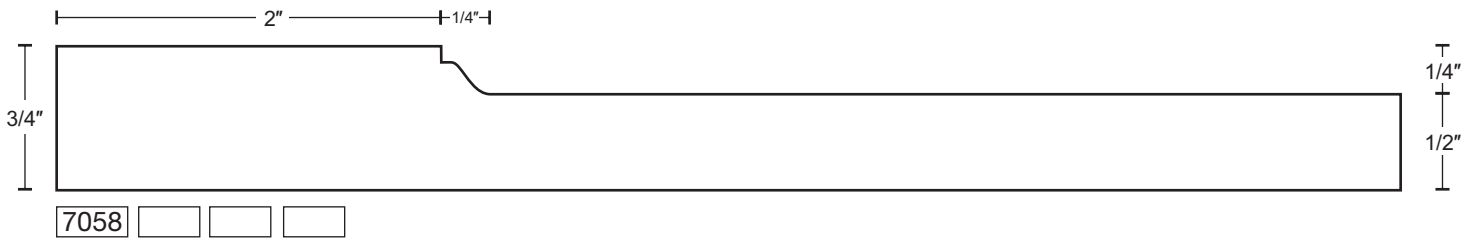

1 piece MDF series

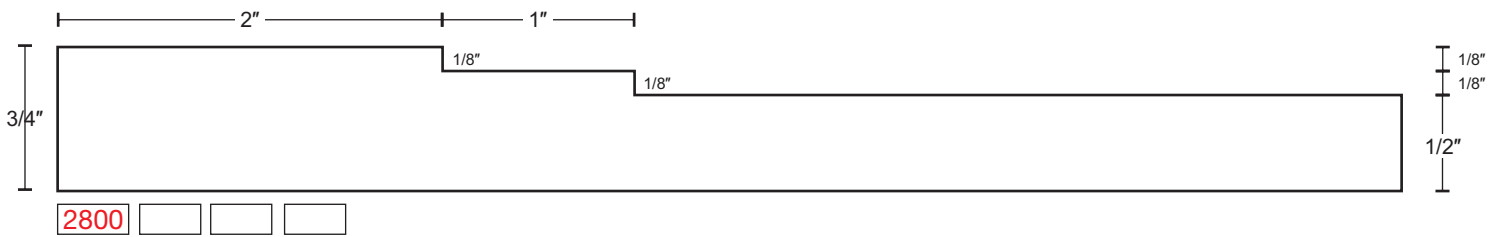
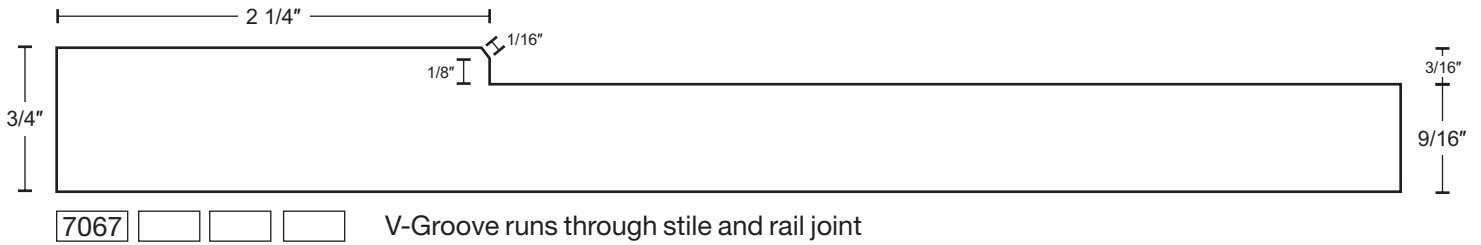

2 piece MDF series

Inside profiles can be combined with any of the profiles in the outside profile pages

All profiles also available in 1 piece MDF

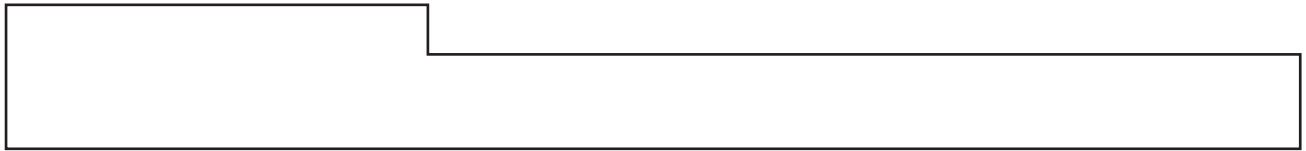

4 75
INSIDE OUTSIDE



V-Groove runs through stile and rail joint 5 65
INSIDE OUTSIDE

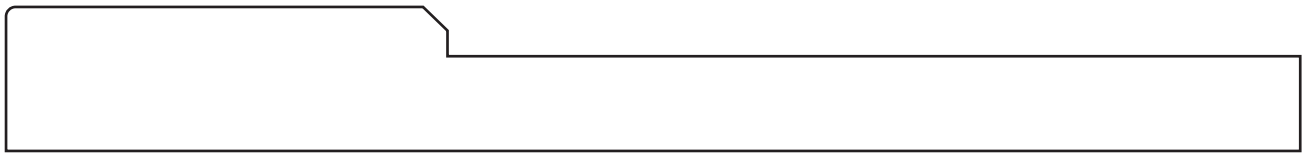

V-Groove does NOT run through stile and rail joint 7 76
INSIDE OUTSIDE

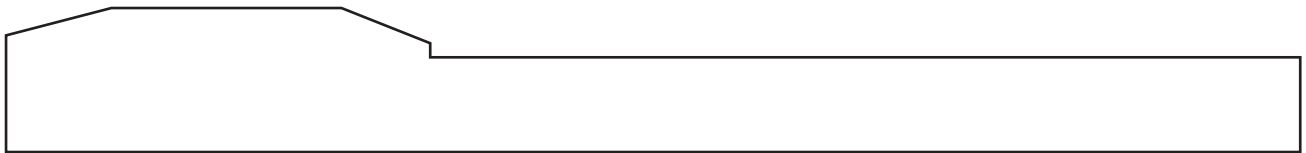

8m 68
INSIDE OUTSIDE

2 piece MDF series

Inside profiles can be combined with any of the profiles in the outside profile pages

All profiles also available in 1 piece MDF

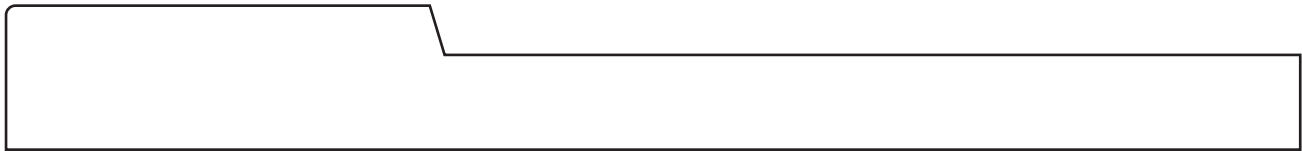

12 76
INSIDE OUTSIDE

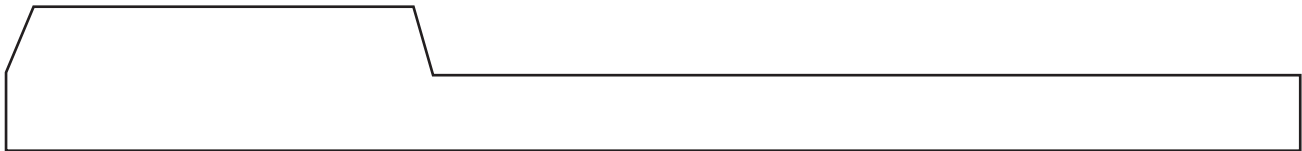

12 3/8 77
INSIDE OUTSIDE

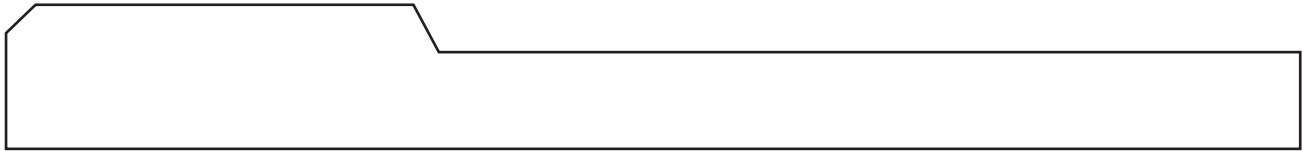

13 65
INSIDE OUTSIDE

mouldings

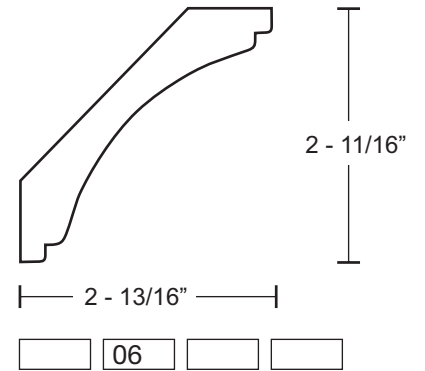
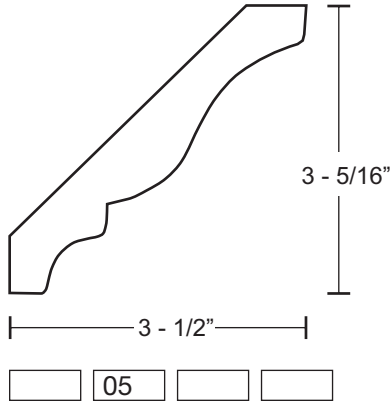
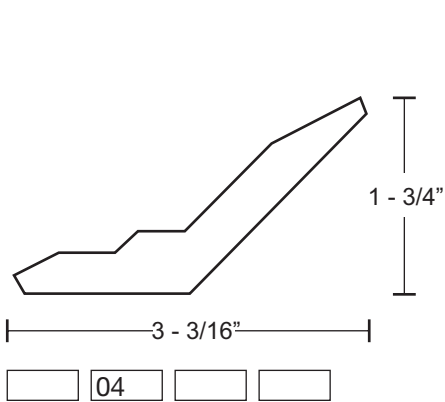
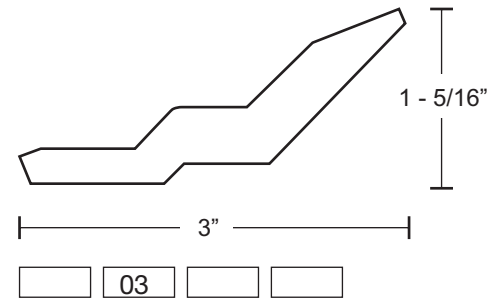
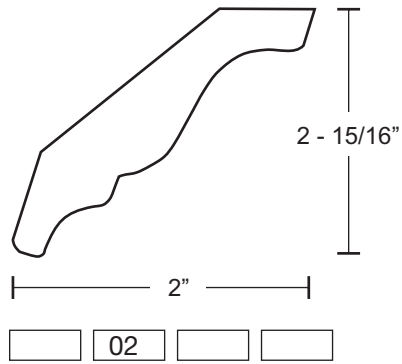
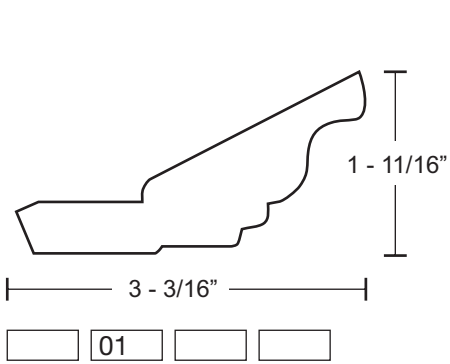

mouldings

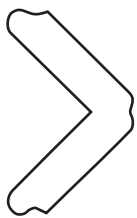
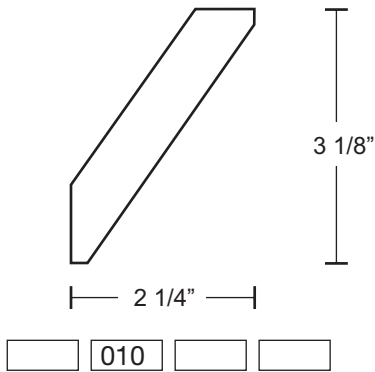
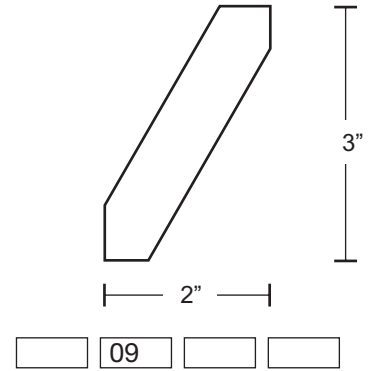
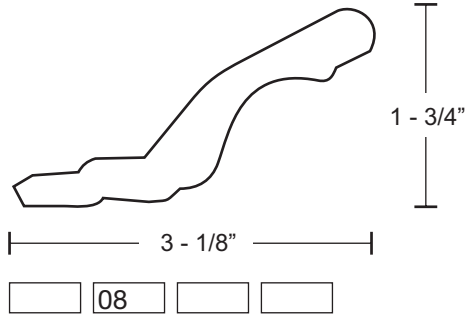
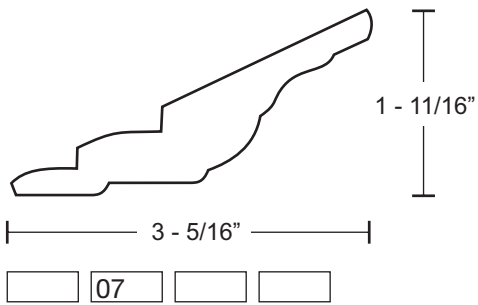

90° Corner



45° Corner

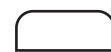

Batten

Order:

Quote:

PO#:

Job:

CE#:

Phone:

Fax:

Ship Via:

Ordered:

Required:

ORDER

Wood Species

Profiles: **Inside**

Raise

Outside

Finish

Style	Qty	Size (width x height)	Internal Use
<input type="text"/>	<input type="text"/>	<input type="text"/>	<input type="text"/>
<input type="text"/>	<input type="text"/>	<input type="text"/>	<input type="text"/>
<input type="text"/>	<input type="text"/>	<input type="text"/>	<input type="text"/>
<input type="text"/>	<input type="text"/>	<input type="text"/>	<input type="text"/>
<input type="text"/>	<input type="text"/>	<input type="text"/>	<input type="text"/>
<input type="text"/>	<input type="text"/>	<input type="text"/>	<input type="text"/>
<input type="text"/>	<input type="text"/>	<input type="text"/>	<input type="text"/>
<input type="text"/>	<input type="text"/>	<input type="text"/>	<input type="text"/>
<input type="text"/>	<input type="text"/>	<input type="text"/>	<input type="text"/>
<input type="text"/>	<input type="text"/>	<input type="text"/>	<input type="text"/>
<input type="text"/>	<input type="text"/>	<input type="text"/>	<input type="text"/>
<input type="text"/>	<input type="text"/>	<input type="text"/>	<input type="text"/>
<input type="text"/>	<input type="text"/>	<input type="text"/>	<input type="text"/>
<input type="text"/>	<input type="text"/>	<input type="text"/>	<input type="text"/>
<input type="text"/>	<input type="text"/>	<input type="text"/>	<input type="text"/>
<input type="text"/>	<input type="text"/>	<input type="text"/>	<input type="text"/>
<input type="text"/>	<input type="text"/>	<input type="text"/>	<input type="text"/>
<input type="text"/>	<input type="text"/>	<input type="text"/>	<input type="text"/>
<input type="text"/>	<input type="text"/>	<input type="text"/>	<input type="text"/>
<input type="text"/>	<input type="text"/>	<input type="text"/>	<input type="text"/>
<input type="text"/>	<input type="text"/>	<input type="text"/>	<input type="text"/>
<input type="text"/>	<input type="text"/>	<input type="text"/>	<input type="text"/>
<input type="text"/>	<input type="text"/>	<input type="text"/>	<input type="text"/>
<input type="text"/>	<input type="text"/>	<input type="text"/>	<input type="text"/>

Style	Qty	Size (width x height)	Internal Use
<input type="text"/>	<input type="text"/>	<input type="text"/>	<input type="text"/>
<input type="text"/>	<input type="text"/>	<input type="text"/>	<input type="text"/>
<input type="text"/>	<input type="text"/>	<input type="text"/>	<input type="text"/>
<input type="text"/>	<input type="text"/>	<input type="text"/>	<input type="text"/>
<input type="text"/>	<input type="text"/>	<input type="text"/>	<input type="text"/>
<input type="text"/>	<input type="text"/>	<input type="text"/>	<input type="text"/>
<input type="text"/>	<input type="text"/>	<input type="text"/>	<input type="text"/>
<input type="text"/>	<input type="text"/>	<input type="text"/>	<input type="text"/>
<input type="text"/>	<input type="text"/>	<input type="text"/>	<input type="text"/>
<input type="text"/>	<input type="text"/>	<input type="text"/>	<input type="text"/>
<input type="text"/>	<input type="text"/>	<input type="text"/>	<input type="text"/>
<input type="text"/>	<input type="text"/>	<input type="text"/>	<input type="text"/>
<input type="text"/>	<input type="text"/>	<input type="text"/>	<input type="text"/>
<input type="text"/>	<input type="text"/>	<input type="text"/>	<input type="text"/>
<input type="text"/>	<input type="text"/>	<input type="text"/>	<input type="text"/>
<input type="text"/>	<input type="text"/>	<input type="text"/>	<input type="text"/>
<input type="text"/>	<input type="text"/>	<input type="text"/>	<input type="text"/>
<input type="text"/>	<input type="text"/>	<input type="text"/>	<input type="text"/>
<input type="text"/>	<input type="text"/>	<input type="text"/>	<input type="text"/>
<input type="text"/>	<input type="text"/>	<input type="text"/>	<input type="text"/>
<input type="text"/>	<input type="text"/>	<input type="text"/>	<input type="text"/>
<input type="text"/>	<input type="text"/>	<input type="text"/>	<input type="text"/>
<input type="text"/>	<input type="text"/>	<input type="text"/>	<input type="text"/>

Additional Requirements

Subtotal \$ Shipping \$ PST \$ GST \$

TOTAL \$

Pcs/Wt

Ship Date

Invoice#

Terms: 2% interest per month charged on al accounts over 30 days (24%per year)